



Installation Instructions

DeviceNet Digital Base Terminal Block CompactBlock LDX I/O

Catalog Numbers 1790D-T16BV0, 1790D-T8BV8V,
1790D-T8BV8B, 1790D-T0B16, 1790D-T0V16, 1790D-T0W6,
1790D-T8A0, 1790D-T0A6, Series A

Topic	Page
Important User Information	2
Prevent Electrostatic Discharge	3
Power Supply	4
Environment and Enclosure	5
North American Hazardous Location Approval	6
Before You Begin	7
Install the Base Block	7
Set the Node Address	7
Mount the Base Block	8
Mount on a Panel	9
Mount on DIN Rail	10
Mount the Optional Expansion Block	10
Wire the Terminal Block	11
Connect the DeviceNet Cable	15
Interpret the LED Indicators	16
Specifications	19

Important User Information

Solid state equipment has operational characteristics differing from those of electromechanical equipment. Safety Guidelines for the Application, Installation and Maintenance of Solid State Controls (publication SGI-1.1 available from your local Rockwell Automation sales office or online at <http://literature.rockwellautomation.com>) describes some important differences between solid state equipment and hard-wired electromechanical devices. Because of this difference, and also because of the wide variety of uses for solid state equipment, all persons responsible for applying this equipment must satisfy themselves that each intended application of this equipment is acceptable.





In no event will Rockwell Automation, Inc. be responsible or liable for indirect or consequential damages resulting from the use or application of this equipment.

The examples and diagrams in this manual are included solely for illustrative purposes. Because of the many variables and requirements associated with any particular installation, Rockwell Automation, Inc. cannot assume responsibility or liability for actual use based on the examples and diagrams.

No patent liability is assumed by Rockwell Automation, Inc. with respect to use of information, circuits, equipment, or software described in this manual.

Reproduction of the contents of this manual, in whole or in part, without written permission of Rockwell Automation, Inc., is prohibited.

Throughout this manual, when necessary, we use notes to make you aware of safety considerations.

WARNING 	Identifies information about practices or circumstances that can cause an explosion in a hazardous environment, which may lead to personal injury or death, property damage, or economic loss.
IMPORTANT	Identifies information that is critical for successful application and understanding of the product.
ATTENTION 	Identifies information about practices or circumstances that can lead to personal injury or death, property damage, or economic loss. Attentions help you to identify a hazard, avoid a hazard and recognize the consequences.
SHOCK HAZARD 	Labels may be located on or inside the equipment, for example, a drive or motor, to alert people that dangerous voltage may be present.
BURN HAZARD 	Labels may be located on or inside the equipment, for example, a drive or motor, to alert people that surfaces may be dangerous temperatures.

Prevent Electrostatic Discharge

ATTENTION

This equipment is sensitive to electrostatic discharge, which can cause internal damage and affect normal operation. Follow these guidelines when you handle this equipment:

- Touch a grounded object to discharge potential static.
 - Wear an approved grounding wriststrap.
 - Do not touch connectors or pins on component boards.
 - Do not touch circuit components inside the equipment.
 - Use a static-safe workstation, if available.
 - Store the equipment in appropriate static-safe packaging when not in use.
-

Power Supply

ATTENTION

1790D-T0V16, 1790D-T0B16

To comply with the CE Low Voltage Directive (LVD), the DeviceNet network and outputs must be powered from a source compliant with Safety Extra Low Voltage (SELV) or Protected Extra Low Voltage (PELV).

To comply with UL restrictions, the DeviceNet network must be powered from a source compliant with Class 2 or Limited Voltage/Current.

1790D-T8BV8V, 1790D-T8BV8B

To comply with the CE Low Voltage Directive (LVD), the DeviceNet network and I/O must be powered from a source compliant with the Safety Extra Low Voltage (SELV) or Protected Extra Low Voltage (PELV).

To comply with UL restrictions, the DeviceNet network must be powered from a source compliant with Class 2 or Limited Voltage/Current.

1790D-T0W6

To comply with the CE Low Voltage Directive (LVD), the DeviceNet network and relay coil power must be powered from a source compliant with Safety Extra Low Voltage (SELV) or Protected Extra Low Voltage (PELV).

To comply with UL restrictions, the DeviceNet network must be powered from a source compliant with Class 2 or Limited Voltage/Current.

1790D-T16BV0

To comply with the CE Low Voltage Directive (LVD), the DeviceNet network and output devices must be powered from a source compliant with Safety Extra Low Voltage (SELV) or Protected Extra Low Voltage (PELV).

To comply with UL restrictions, the DeviceNet network must be powered from a source compliant with Class 2 or Limited Voltage/Current.

1790D-T0A6, 1790D-T8A0

To comply with the CE Low Voltage Directive (LVD), the DeviceNet network must be powered from a source compliant with Safety Extra Low Voltage (SELV) or Protected Extra Low Voltage (PELV).

To comply with UL restrictions, the DeviceNet network must be powered from a source compliant with Class 2 or Limited Voltage/Current.

Environment and Enclosure

ATTENTION

This equipment is intended for use in a Pollution Degree 2 industrial environment, in overvoltage Category II applications (as defined in IEC publication 60664-1), at altitudes up to 2000 m (6561 ft) without derating.

This equipment is considered Group 1, Class A industrial equipment according to IEC/CISPR Publication 11. Without appropriate precautions, there may be potential difficulties ensuring electromagnetic compatibility in other environments due to conducted as well as radiated disturbance.



This equipment is supplied as open-type equipment. It must be mounted within an enclosure that is suitably designed for those specific environmental conditions that will be present and appropriately designed to prevent personal injury resulting from accessibility to live parts.

The enclosure must have suitable flame-retardant properties to prevent or minimize the spread of flame, complying with a flame spread rating of 5V A, V2, V1, V0 (or equivalent) if nonmetallic. The interior of the enclosure must be accessible only by the use of a tool. Subsequent sections of this publication may contain additional information regarding specific enclosure-type ratings that are required to comply with certain product safety certifications.

Besides this publication, see:

- Industrial Automation Wiring and Grounding Guidelines, Allen-Bradley publication 1770-4.1, for additional installation requirements.
 - NEMA Standards publication 250 and IEC publication 60529, as applicable, for explanations of the degrees of protection provided by different types of enclosure.
-

North American Hazardous Location Approval

<p>The following information applies when operating this equipment in hazardous locations.</p>	<p>Informations sur l'utilisation de cet équipement en environnements dangereux.</p>
<p>Products marked CL I, DIV 2, GP A, B, C, D are suitable for use in Class I Division 2 Groups A, B, C, D, hazardous locations and nonhazardous locations only. Each product is supplied with markings on the rating nameplate indicating the hazardous location temperature code. When combining products within a system, the most adverse temperature code (lowest "T" number) may be used to help determine the overall temperature code of the system. Combinations of equipment in your system are subject to investigation by the local Authority Having Jurisdiction at the time of installation.</p>	<p>Les produits marqués CL I, DIV 2, GP A, B, C, D ne conviennent qu'à une utilisation en environnements de Classe I Division 2 Groupes A, B, C, D dangereux et non dangereux. Chaque produit est livré avec des marquages sur sa plaque d'identification qui indiquent le code de température pour les environnements dangereux. Lorsque plusieurs produits sont combinés dans un système, le code de température le plus défavorable (code de température le plus faible) peut être utilisé pour déterminer le code de température global du système. Les combinaisons d'équipements dans le système sont sujettes à inspection par les autorités locales qualifiées au moment de l'installation.</p>
<p>WARNING</p> 	<p>EXPLOSION HAZARD -</p> <ul style="list-style-type: none"> • Do not disconnect equipment unless power has been removed or the area is known to be nonhazardous. • Do not disconnect connections to this equipment unless power has been removed or the area is known to be nonhazardous. Secure any external connections that mate to this equipment by using screws, sliding latches, threaded connectors, or other means provided with this product. • Substitution of components may impair suitability for Class I, Division 2. • If this product contains batteries, they must only be changed in an area known to be nonhazardous.
<p>AVERTISSEMENT</p> 	<p>RISQUE D'EXPLOSION –</p> <ul style="list-style-type: none"> • Couper le courant ou s'assurer que l'environnement est classé non dangereux avant de débrancher l'équipement. • Couper le courant ou s'assurer que l'environnement est classé non dangereux avant de débrancher les connecteurs. Fixer tous les connecteurs externes reliés à cet équipement à l'aide de vis, loquets coulissants, connecteurs filetés ou autres moyens fournis avec ce produit. • La substitution de composants peut rendre cet équipement inadapté à une utilisation en environnement de Classe 1, Division 2. • S'assurer que l'environnement est classé non dangereux avant de changer les piles.

Before You Begin

Read this section about important CompactBlock requirements.

Current functions of CompactBlock LDX I/O blocks require the current, modular electronic data sheet (EDS) file for RSNetWorx for DeviceNet software, version 3.0 or later. These files are available online at www.ab.com/networks/eds/.

EDS files for blocks with matching catalog numbers for both D-Shell and terminal block versions are the same. On the Web site and in RSNetWorx for DeviceNet software, find the EDS file for both versions of the blocks. For example, for the EDS file for 1790D-T8BV8B blocks, use the EDS file labelled 1790D-8BV8B.

Install the Base Block

To install the base block, follow these steps.

1. Set the node address on the base block.
2. Mount the base block.
3. Mount the optional expansion blocks.
4. Wire the terminal block.
5. Connect the DeviceNet cable.

Set the Node Address

When setting the node address on the base block, note that each base block comes with its internal program set for node address 63. To reset the node address, adjust the switches on the front of the base block. The two switches are most significant digit (MSD) and least significant digit (LSD). You can set switches between 00 and 63.

The base block reads the rotary switches only when power is applied. Switch settings between 64 and 99 cause the base block to use the last valid node address stored internally.

In this example, the node address setting is 11.

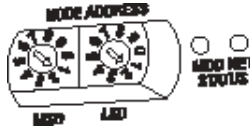

44152

You can also set the node address through RSNetWorx for DeviceNet software or a similar configuration tool.

When you use software configuration for the node address, set the switches between 64 and 99.

Mount the Base Block

Mount the base block to a panel or DIN rail. We recommend that you ground the panel or DIN rail before mounting the block.

IMPORTANT

The analog base module can accommodate a maximum of two digital expansion modules.

Mount on a Panel

For panel mounting, use these steps.

1. Place the block against the panel where you want it mounted.
2. Gently pull and position the expansion cover to the left.
3. Place a center punch, nail, or similar device through the mounting holes in the block and make two marks on the panel at the lower-left and upper-right corners of the module.
4. Remove the block and drill two holes in the panel to accommodate each of the mounting screws.

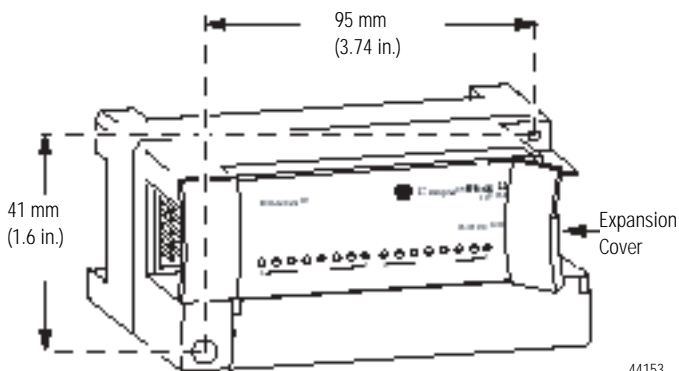

5. Replace the block on the panel and place a screw through each of the two mounting holes.
6. Tighten the screws until the block is firmly in place.

Mount on DIN Rail

For DIN-rail mounting, use these steps.

1. Hook the top slot of the base block over the DIN rail.

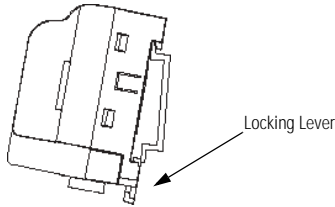

44154

2. Pull down on the locking lever while pressing the base block against the rail.
3. Push up on the locking lever to secure the base block to the rail when the base block is flush against the rail.

Mount the Optional Expansion Block

Mount the expansion block by connecting it to a previously-installed CompactBlock LDX I/O base or expansion block.

Beginning with the base block, mount your expansion block either horizontally or vertically.

- To mount horizontally (left to right), add an expansion block in an end-to-end configuration.
- To mount vertically (up or down), add an expansion block either up or down in a back-to-back configuration. In this configuration, you must use the optional 15 cm (5.9 in.) ribbon cable (1790-15CMCBL) and alternately position the block in a right-side up, upside-down fashion.

Mount your block on a panel or DIN rail.

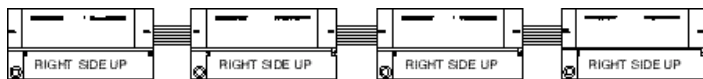

Horizontal Mounting

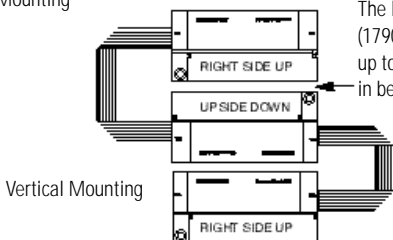

Vertical Mounting

The longer expansion cable (1790-15CMCBL) provides for up to 7 cm (2.76 in.) of space in between blocks.

44155

Wire the Terminal Block

WARNING



If you connect or disconnect wiring while the field-side power is on, an electrical arc can occur. This could cause an explosion in hazardous location installations. Be sure that power is removed or the area is nonhazardous before proceeding.

See the figures for wiring information.

1790D-T16BVO Input Base Block Wiring Diagram

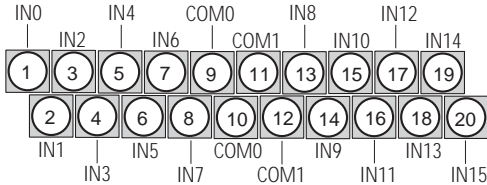

44178

For inputs 0...7: For sinking inputs, wire COM 0 (pin 9) to Field Power (-) GND.
 For sourcing inputs, wire COM 0 (pin 9) to Field Power (+) 24V dc.

For inputs 8...15: For sinking inputs, wire COM 1 (pin 11) to Field Power (-) GND.
 For sourcing inputs, wire COM 1 (pin 11) to Field Power (+) 24V dc.

Note that both COM 0 and COM 1 are internally connected. COM 0 is used for inputs 0...7.
 COM 1 is used for inputs 8...15.

1790D-T8BV8V Input/Output Base Block Wiring Diagram

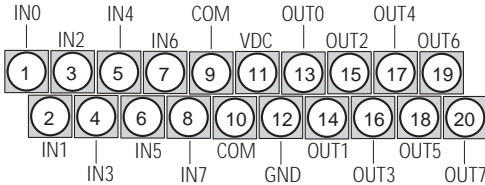

44179

For sinking inputs, wire COM (pin 9) to Field Power (-) GND.
 For sourcing inputs, wire COM (pin 9) to Field Power (+) 24V dc.
 Note that both COM (pins 9 and 10) are internally connected.

For sinking outputs, wire V dc (pin 11) to Field Power (+) 24V dc, and
 wire GND (pin 12) to Field Power (-) GND.

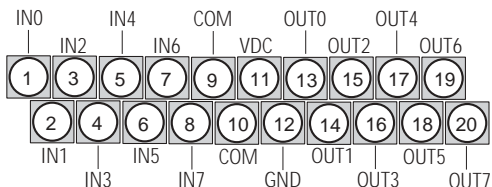
1790D-T8BV8B Input/Output Base Block Wiring Diagram

44180

For sinking inputs, wire COM (pin 9) to Field Power (-) GND.

For sourcing inputs, wire COM (pin 9) to Field Power (+) 24V dc.

Note that COM (pins 9 and 10) are internally connected.

For sourcing outputs, wire V dc (pin 11) to Field Power (+) 24V dc, and

wire GND (pin 12) to Field Power (-) GND.

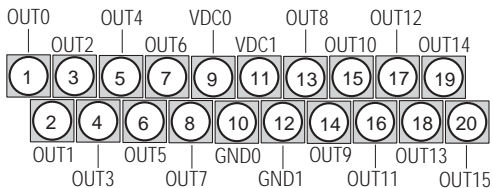
1790D-T0B16 Output Base Block Wiring Diagram

44181

For sourcing outputs, wire V dc 0 (pin 9) and V dc 1 (pin 11) to Field Power (+) 24V dc, and wire GND0 (pin 10) and GND1 (pin 12) to Field Power (-) GND.

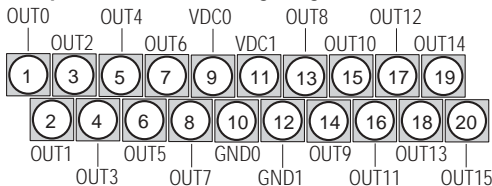
1790D-T0V16 Output Base Block Wiring Diagram

44182

For sinking outputs, wire V dc 0 (pin 9) and V dc 1 (pin 11) to Field Power (+) 24V dc, and wire GND0 (pin 10) and GND1 (pin 12) to Field Power (-) GND.

1790D-T0W6 Relay Output Base Block Wiring Diagram

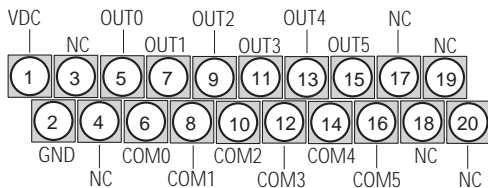

44183

Wire V dc (pin 1) to Field Power (+) 24V dc.

Wire GND (pin 2) to Field Power (-) GND.

1790D-T8A0 ac Input Base Block Wiring Diagram

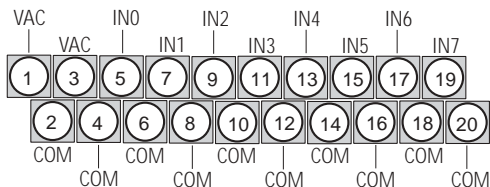

44184

Wire 120V ac Field Power to V ac (pin 1) and COM (pin 2).

Note that all V ac are internally connected. All COM are internally connected.

1790D-T0A6 ac Output Base Block Wiring Diagram

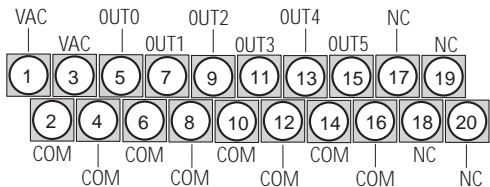

44185

Wire 120V ac Field Power to V ac (pin 1) and COM (pin 2).

Note that all V ac are internally connected. All COM are internally connected.

Connect the DeviceNet Cable

Follow these procedures to connect the DeviceNet cable to the base block. We do not supply the DeviceNet connector with the base block. You must purchase the connector separately. These are the types of connectors you order directly from Rockwell Automation.

- 1799-DNETCON - 5-position open-style connector
- 1799-DNETSCON - 5-position open-style connector with locking screws
- 1799-DNC5MMS - 5-position open-style to 12 mm connector with locking screws

WARNING



If you connect or disconnect the DeviceNet cable with power applied to this module or any device on the network, an electrical arc can occur. This could cause an explosion in hazardous location installations.

Be sure that power is removed or the area is nonhazardous before proceeding.

1. Connect the DeviceNet wiring (drop line) to one of the DeviceNet connectors as shown in the figure, noting that a color-coded wiring diagram is printed next to the connector on the left side of the base block.

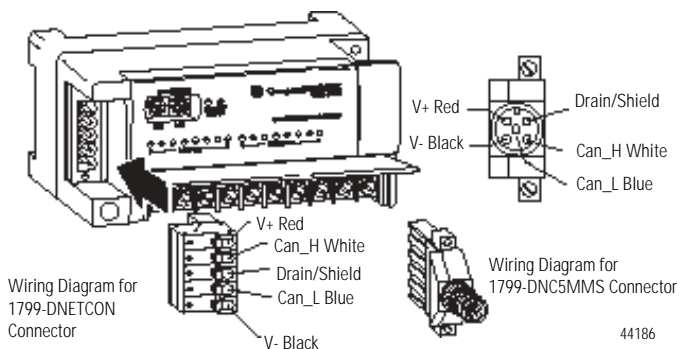

2. Attach the connector to the base block once you have properly wired the drop line to the connector.
3. Use the locking screws on the connector to fasten it to the base block, if applicable.

Interpret the LED Indicators

Read this section for information about how to interpret base block LED indicators. The base block has the following indicators.

- Block status
- Network status
- I/O status

If a module status indicator is flashing red, refer to the cable break procedures section.

Indication	Probable Cause	Recommended Action
Module Status		
Solid Red	Unrecoverable fault in base unit.	Replace base block.
Flashing Red	Fault in expansion unit.	Reconnect or replace, as needed.
Solid Green	Normal operation.	None.
Off	No power.	Apply power to device.
Network Status		
Solid Red	Module node number is a duplicate of an existing node, or network communication issues exist.	Change module node number to an unused address, or verify network wiring is correct and communication is stable.
Flashing Red	An I/O connection has timed out.	Cycle power to the module.

Indication	Probable Cause	Recommended Action
Solid Green	The module is operating in a normal condition, and the module is online with connections in the established state. As a group 2 module, the module is allocated to a master.	None.
Flashing Green	The module is online with no connections in the established state.	Establish connections to other nodes. As a group 2 module, allocate the module to a master.
Off	No power.	Wait until the module has completed the dup_MAC_id test or power the module.

Function	LED Color	Module Illumination	Condition
I/O Status			
Outputs	Each output: Green	None Green	Output is not energized. Output is energized.
Inputs	Each input: Green	None Green	No valid input is present. Valid input is present.

Cable Break Procedures

A cable break in any location between either of the following produces data of 1 in the data table for all inputs down stream of the cable break.

- Base and digital input expansion module
- Digital input expansion module and another digital input expansion module

All digital-expansion inputs produce data of 1 if the expansion cable is removed. No status is in the produced assembly. Attribute 101 in the identity object reports module faults. If no faults are present, an explicit message GET command returns 0. If the ribbon cable is disconnected, it returns 0x04, which is for module location change. The module LED also flashes indicating a fault if an expansion is disconnected.

To determine if the data is valid, continuously send an explicit message to the module to check the status of the input conditions since no status word is in the I/O mapping data table.

- Class = 1
- Instance = 1
- Attribute = 101 (0x65)

To detect the loss of communication to the expansion module, use one of these methods.

- If an unused input is available, tie the unused input on the last expansion low. If that input goes high with a value of 1, a loss of communication to the expansion or expansions occurred.
- If no unused input is available, check expansion inputs for the condition of all on. To check validity in this case, send an explicit message to the identity object class 1, instance 1, attribute 101 (0x65). A returned value of 0 indicates the input data is good.

Specifications

1790D-T16BV0 Universal dc Input Base Block

Attribute	Value
Inputs per Base Block	16 point, sinking or sourcing
On-state Voltage	9.6V dc min, 24V dc nom, 28.8V dc max
Off-state Voltage	5.0V dc max
On-state Current	8 mA max per channel @ 28.8V dc
Input Impedance, Nom	4.8 k Ω
Field Power Dissipation	3.68 W max @ 28.8V dc
Isolation Voltage	50V dc (continuous), reinforced insulation type, tested at 1250V ac for 60 s, I/O to system

1790D-TOV16 and 1790D-TOB16 dc Output Base Block

Attribute	Value
Outputs per Base Block	16 points non-isolated, sinking: 1790D-TOV16 16 points non-isolated, sourcing: 1790D-TOB16
On-state Voltage	10V dc min, 24Vdc nom, 28.8V dc max
On-state Voltage Drop	0.5V dc max
On-state Current	1 mA min per channel
Off-state Voltage	28.8V dc max
Off-state Leakage	0.5 mA max
Output Signal Delay	Off to On: 0.5 ms max, On to Off: 1.0 ms max
Output Current Rating	0.5 A max per output, 4.0 A max per common
Field Power Dissipation	2.76 W @ 28.8V dc
Isolation Voltage	50V dc (continuous), reinforced insulation type, tested at 1250V ac for 60 s, I/O to system

1790D-T8BV8V, 1790D-T8BV8B dc Input/Output Combination Base Block

Attribute	Value
Field Power Dissipation	3.22 W @ 28.8V dc
Isolation Voltage	50V dc (continuous), reinforced insulation type, tested at 1250V ac for 60 s, I/O to system
Input	
Inputs per Base Block	8 points non-isolated, sinking or sourcing
On-state Voltage	9.6V dc min 24V dc nom 28.8V dc max
Off-state Voltage, Max	5.0V dc
On-state Current	8 mA max per channel @ 28.8V dc
Input Impedance, Nom	4.8 k Ω
Output	
Outputs per Base Block	8 points non-isolated, sinking - 1790D-T8BV8V 8 points non-isolated, sourcing - 1790D-T8BV8B
On-state Voltage,	10V dc min 24V dc nom 28.8V dc max
On-state Voltage Drop	0.5V dc max
On-state Current	1 mA min per channel
Off-state Leakage	0.5 mA max
Output Signal Delay, Off to On	0.5 ms max
Output Signal Delay, On to Off	1.0 ms max
Output Current Rating	0.5 A max per output 4.0 A max per common

1790D-TOW6 ac/dc Relay Output Base Block

Attribute	Value
Relay Type	Form A, normally open Single pole, single throw
Output Voltage Range (load dependent)	5...28V dc @ 2.0 A resistive 48V dc @ 0.8 A resistive 125V ac @ 2.0 A resistive 250V ac @ 2.0 A resistive
Load, Min	100 μ A, 100 mV dc per point
On-state Voltage Drop, Max	0.5V @ 2.0 A, resistive load, 24V dc
Initial Contact Resistance	30 m Ω
Expected Contact Life	300 kcycles resistive 100 kcycles inductive
Off-state Leakage, Max	1.5 mA
Output Delay Time, On to Off	10 ms max
Output Delay Time, Off to On	10 ms max
Relay Coil Power Dissipation	1.7 W @ 28.8V dc
Isolation Voltage	50V dc (continuous), reinforced insulation type, tested at 1250V ac for 60 s, I/O to system

1790D-T8AO ac Input Base Block

Attribute	Value
Inputs per Expansion Block	8 points non-isolated
On-state Voltage Range	79V ac min 110V ac nom 132V ac max
Input Impedance	18 k Ω
On-state Current	9 mA max @ 132V ac

1790D-T8AO ac Input Base Block

Attribute	Value
Off-state Current	45V ac max
Input Signal Delay, Off to On	10 ms
Input Signal Delay, On to Off	30 ms max
Field Power Dissipation	3VA @ 132V ac
Isolation Voltage	120V ac (continuous), reinforced insulation type, tested at 1250V ac for 60 s, I/O to system

1790D-TOA6 Output Base Block

Attribute	Value
Outputs per Expansion Block	6 points non-isolated
Load Voltage Range	15...132V ac
Load Current, Max	0.5 A rms
Load Current, Min	10 mA rms
Off-state Leakage Current, Max	1.0 mA rms @ 100V rms 60 Hz
On-state Voltage Drop, Max	1.3V rms @ max load
Operate Time, Max	1 ms
Release, Max	1/2 cycle + 1 ms
Insulation Resistance	1,000 M Ω min (for input-output)
Input Signal Delay, Off to On	10 ms

1790D-TOA6 Output Base Block

Input Signal Delay, On to Off	30 ms max
Field Power Dissipation	3.9VA @ rated current
Isolation Voltage	120V ac (continuous), reinforced insulation type, tested at 1250V ac for 60 s, I/O to system

Environmental - Common To All Base Blocks in This Publication

Attribute	Value
Operating Temperature	IEC 60068-2-1 (Test Ad, Operating Cold), IEC 60068-2-2 (Test Bd, Operating Dry Heat), IEC 60068-2-14 (Test Nb, Operating Thermal Shock) 0...55 °C (32...131 °F)
Storage Temperature	IEC60068-2-1 (Test Ab, Unpackaged Nonoperating Cold) IEC60068-2-2 (Test Bb, Unpackaged Nonoperating Dry Heat) IEC60068-2-14 (Test Na, Unpackaged Nonoperating Thermal Shock) -40...85 °C (-40...185 °F)
Relative Humidity	IEC60068-2-30 (Test Db, Unpackaged Damp Heat) 5...90% noncondensing
North American Temp Code	T5
Vibration	IEC 60068-2-6 (Test Fc, Operating): 2 g @ 10...500 Hz
Shock Operating	IEC60068-2-27 (Test Ea, Unpackaged Shock) 10 g
Shock Non-operating	IEC60068-2-27 (Test Ea, Unpackaged Shock) 30 g
Emissions	CISPR 11: Group 1, Class A
ESD Immunity	IEC6100-4-2 8 kV air discharges
Radiated RF Immunity	IEC 61000-4-3 10V/m with 1 kHz sine-wave 80%AM from 80...1000 MHz 10V/m with 200 Hz 50% Pulse 100%AM at 900 MHz

Environmental - Common To All Base Blocks in This Publication

EFT/B Immunity	IEC 61000-4-4 ±1 kV at 5 kHz on power ports ±2 kV at 5 kHz on signal ports ±2 kV at 5 kHz on communications ports
Surge Transient Immunity	IEC 61000-4-5: ±1 kV line-line (DM) on power ports ±1 kV line-line (DM) on signal ports ±2 kV line-earth (CM) on communications ports
Conducted RF Immunity	IEC61000-4-6 10V rms with 1 kHz sine-wave 80%AM at 150 kHz...80 MHz
Enclosure Type Rating	None (open-style)
Mounting	DIN rail or panel
Dimension	52 x 104 x 42 mm (2.03 x 4.07 x 1.64 in.)
Weight	0.1 kg (0.3 lb)
Wiring, Terminal Block (M3.0) Screw Torque	7 lb-in max (use copper or copper-clad aluminum conductors)
Wire Size	2.5...0.25 mm ² (14 ...22 AWG) solid or stranded copper wire rated at 75 °C or greater 1.2 mm (3/64 in.) insulation max
Wiring Category ⁽¹⁾	2 - on signal ports 2 - on power ports 2 - on communications ports
dc Field Power	Supply voltage - 24V dc nom Voltage range - 10...28.8V dc
dc Relay Coil Power	Supply voltage - 24V dc nom Voltage range - 19.2...28.8V dc
ac Field Power	Supply voltage - 115V ac, 60 Hz Voltage range - 85...132V ac, 47...63 Hz
DeviceNet	
DeviceNet Power	Supply voltage - 24V dc nom Voltage range - 8...28V dc

Environmental - Common To All Base Blocks in This Publication

DeviceNet Power Dissipation	1.2 W max @ 28.8V dc
Network Length	500 m (1640 ft) max @ 125 Kbps 100 m (328 ft) max @ 500 Kbps
Network Protocol	Slave messaging: <ul style="list-style-type: none"> • Poll command • Bit Strobe command • Cyclic command • COS command
Indicators	1 red/green module status, 1 red/green network status
Number of Nodes	64 max - rotary switch-type node address setting
Communication Rate	125 Kbps, 250 Kbps, 500 Kbps - auto baud rate selection

⁽¹⁾ Use this Conductor Category information for planning conductor routing. Refer to Industrial Automation Wiring and Grounding Guidelines, publication 1770-4.1.

Certifications

Attribute	Value
Certification ⁽¹⁾ (when product is marked)	<p>1790D-TOV16, 1790D-TOB16, 1790D-T8BV8V, 1790D-T8BV8B, 1790D-T16BV0</p> <p>c-UL-us UL Listed Industrial Control Equipment, certified for U.S. and Canada. See UL File E65584.</p> <p>c-UL-us UL Listed for Class I, Division 2, Group A,B,C,D Hazardous Locations, certified for U.S. and Canada. See UL File E194810.</p> <p>European Union 89/336/EEC EMC Directive, compliant with: EN 50082-2; Industrial Immunity EN 61326; Meas./Control/Lab., Industrial Requirements EN 61000-6-2; Industrial Immunity EN 61000-6-4; Industrial Emissions</p> <p>C-Tick Australian Radiocommunications Act, compliant with: AS/NZS CISPR11; Industrial Emissions</p> <p>Open Device Vendors Association (ODVA) conformance tested to DeviceNet specifications</p>
	<p>1790D-T8A0, 1790D-T0A6, 1790D-T0W6</p> <p>c-UL-us UL Listed Industrial Control Equipment, certified for U.S. and Canada. See UL File E65584.</p> <p>c-UL-us UL Listed for Class I, Division 2, Group A,B,C,D Hazardous Locations, certified for U.S. and Canada. See UL File E194810.</p> <p>European Union 89/336/EEC EMC Directive, compliant with: EN 50082-2; Industrial Immunity EN 61326; Meas./Control/Lab., Industrial Requirements EN 61000-6-2; Industrial Immunity EN 61000-6-4; Industrial Emissions</p> <p>European Union 73/23/EEC LVD, compliant with: EN 61131-2; Programmable Controllers</p> <p>C-Tick Australian Radiocommunications Act, compliant with: AS/NZS CISPR11; Industrial Emissions</p> <p>Open Device Vendors Association (ODVA) conformance tested to DeviceNet specifications</p>

⁽¹⁾ See the Product Certification link at www.ab.com for Declarations of Conformity, Certificates, and other certification details.

Notes:

Rockwell Automation Support

Rockwell Automation provides technical information on the web to assist you in using its products. At <http://support.rockwellautomation.com>, you can find technical manuals, a knowledge base of FAQs, technical and application notes, sample code and links to software service packs, and a MySupport feature that you can customize to make the best use of these tools.

For an additional level of technical phone support for installation, configuration, and troubleshooting, we offer TechConnect Support programs. For more information, contact your local distributor or Rockwell Automation representative, or visit <http://support.rockwellautomation.com>.

Installation Assistance

If you experience a problem with a hardware module within the first 24 hours of installation, please review the information that's contained in this manual. You can also contact a special Customer Support number for initial help in getting your module up and running.

United States	1.440.646.3223 Monday – Friday, 8am – 5pm EST
Outside United States	Please contact your local Rockwell Automation representative for any technical support issues.

New Product Satisfaction Return

Rockwell tests all of its products to ensure that they are fully operational when shipped from the manufacturing facility. However, if your product is not functioning, it may need to be returned.

United States	Contact your distributor. You must provide a Customer Support case number (see phone number above to obtain one) to your distributor in order to complete the return process.
Outside United States	Please contact your local Rockwell Automation representative for return procedure.

Allen-Bradley, CompactBlock, Rockwell Automation, and RSNetworkx are trademarks of Rockwell Automation, Inc. Trademarks not belonging to Rockwell Automation are property of their respective companies.

www.rockwellautomation.com

Power, Control and Information Solutions Headquarters

Americas: Rockwell Automation, 1201 South Second Street, Milwaukee, WI 53204-2496 USA, Tel: (1) 414.382.2000, Fax: (1) 414.382.4444
Europe/Middle East/Africa: Rockwell Automation, Vorstlaan/Boulevard du Souverain 36, 1170 Brussels, Belgium, Tel: (32) 2 663 0600, Fax: (32) 2 663 0640
Asia Pacific: Rockwell Automation, Level 14, Core F, Cyberport 3, 100 Cyberport Road, Hong Kong, Tel: (852) 2887 4788, Fax: (852) 2508 1846

Publication 1790-IN006C-EN-P - May 2006

PN 953014-38

Supersedes Publication 1790-IN006B-EN-P - April 2003

Copyright © 2006 Rockwell Automation, Inc. All rights reserved. Printed in the U.S.A.